

Article number: 07158050001

Description: Universal joint single 0.158.050.001  
S=185 X= Bore with keyway

## Measures

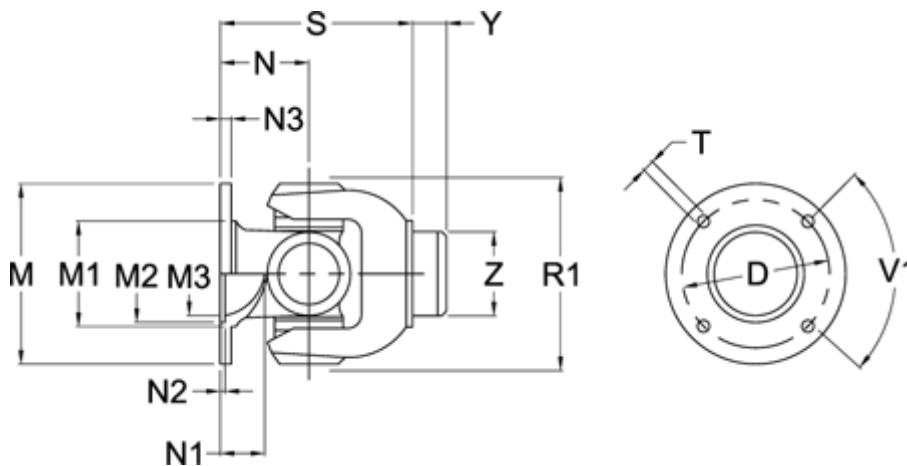

D	= 130 +0,1	N2	= 3 +0,5	Z = 82.25
Flange diameter M	= 150	N3	= 12	
M1	= 104	Number og Flangeholes	= 8	
M2	= 90	R1	= 150	
M3	= 82	S min	= 185	
Max. Bending Angle degrees	= 20	T	= 12 B12	
N	= 75	V1 degrees	= 45	
N1	= 25	Y	= 22	